

- 1024 X 8 Organization
- All Inputs and Outputs Fully TTL Compatible
- Static Operation (No Clocks, No Refresh)
- Max Access/Min Cycle Time

'2708-35	350 ns
'2708-45	450 ns
'27L08-45	450 ns
- 3-State Outputs for OR-Ties
- N-Channel Silicon-Gate Technology
- 8-Bit Output for Use in Microprocessor-Based Systems
- Power Dissipation

'27L08	580 mW Max Active
'2708	800 mW Max Active
- 10% Power Supply Tolerance (TMS27L08-45 and all SMJ' versions)
- Plug-Compatible Pin-Outs Allowing Interchangeability/Upgrade to 16K With Minimum Board Change
- Available in Full Military Temperature Range Versions (SMJ2708)

description

The '2708-35, '2708-45, and '27L08-45 are ultraviolet light-erasable, electrically programmable read-only memories. They have 8,192 bits organized as 1024 words of 8-bit length. The devices are fabricated using N-channel silicon-gate technology for high speed and simple interface with MOS and bipolar circuits. All inputs (including program data inputs) can be driven by Series 54/74 TTL circuits without the use of external pull-up resistors. Each output can drive one Series 54/74 or 54LS/74LS TTL circuit without external resistors. The '27L08 guarantees 200 mV dc noise immunity in the high state and 250 mV in the low state. The data outputs for the '2708-35, '2708-45, and '27L08-45 are three-state for OR-tying multiple devices on a common bus.

TMS2708 . . . JL PACKAGE
SMJ2708 . . . J PACKAGE
(TOP VIEW)

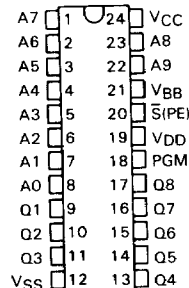

SMJ2708 . . . FE PACKAGE
(TOP VIEW)

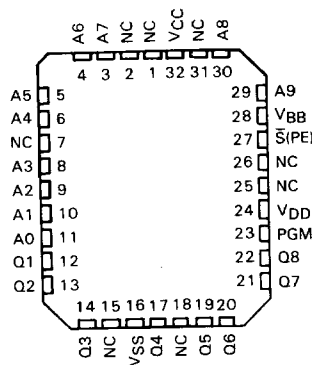

NC - No Connection

PIN NOMENCLATURE	
A0-A7	Address Inputs
NC	No Connection
PGM	Program
Q1-Q8	Data Out
S(PE)	Chip Select/Program Enable
VBB	-5-V Power Supply
VCC	+5-V Power Supply
VDD	+12-V Power Supply
VSS	0-V Ground

6

EPROM Devices

These EPROMs are designed for high-density fixed-memory applications where fast turn arounds and/or program changes are required. The TMS' Series is supplied in a 24-pin dual-in-line ceramic cerdip (JL suffix) package designed for insertion in mounting-hole rows on 600-mil (15.2 mm) centers. They are designed for operation from 0°C to 70°C.

The SMJ' Series is offered in a 24-pin dual-in-line ceramic package (J) and also in a 32-pin leadless ceramic chip carrier (FE). The J package is designed for insertion in mounting-hole rows on 600-mil (15.2 mm) centers whereas the FE package is intended for surface mounting on solder pads on 0.05-inch (1.27 mm) centers. The FE package is a three-layer 32-pad rectangular chip carrier with dimensions of 0.450 × 0.550 × 0.100 inches (11.43 × 13.97 × 2.54 mm). This series is designed for operation from -55°C to 125°C.

operation (read mode)

address (A0-A9)

The address-valid interval determines the device cycle time. The 10-bit positive-logic address is decoded on-chip to select one of the 1024 words of 8-bit length in the memory array. A0 is the least-significant bit and A9 is the most-significant bit of the word address.

chip select, program enable (\bar{S} (PE))

When the chip select is low, all eight outputs are enabled and the eight-bit addressed word can be read. When the chip select is high, all eight outputs are in a high-impedance state.

data out (Q1-Q8)

The chip must be selected before the eight-bit output word can be read. Data will remain valid until the address is changed or the chip is deselected. When deselected, the three-state outputs are in a high-impedance state. The outputs will drive TTL circuits without external components.

program

The program pin must be held below V_{CC} in the read mode.

operation (program mode)

erase

Before programming, the '2708-35, '2708-45, or '27L08-45 is erased by exposing the chip through the transparent lid to high-intensity ultraviolet light that has a wavelength of 253.7 nanometers (2537 Angstroms). The recommended minimum exposure dose (UV intensity × exposure time) is fifteen watt-seconds per square centimeter. Thus, a typical 12 milliwatt per square centimeter, filterless UV lamp will erase the device in a minimum of 21 minutes. The lamp should be located about 2.5 centimeters (1 inch) above the chip during erasure. After erasure, all bits are in the high state.

programming

Programming consists of successively depositing a small amount of charge to a selected memory cell that is to be changed from the erased high state to the low state. A low can be changed to a high only by erasure. Programming is normally accomplished on a PROM or EPROM Programmer, an example of which is TI's Universal PROM Programming Module in conjunction with the 990 prototyping system. Programming must be done at room temperature (25°C) only.

to start programming (see program cycle timing diagram)

First bring the \bar{S} (PE) pin to +12 V to disable the outputs and convert them to inputs. This pin is held high for the duration of the programming sequence. The first word to be programmed is addressed (it is customary to begin with the "0" address) and the data to be stored is placed on the Q1-Q8 program inputs. Then a +25 V program pulse is applied to the program pin. After 0.1 to 1.0 milliseconds the program pin is brought back to 0 V. After at least one microsecond the word address is sequentially changed to the next location, the new data is set up and the program pulse is applied.

1024-WORD BY 8-BIT ERASABLE PROGRAMMABLE READ-ONLY MEMORIES

Programming continues in this manner until all words have been programmed. This constitutes one of N program loops. The entire sequence is then repeated N times with $N \times t_{w(PR)} \geq 100$ ms. Thus, if $t_{w(PR)} = 1$ ms; then $N = 100$, the minimum number of program loops required to program the EPROM.

to stop programming

After cycling through the N program loops, the last program pulse is brought to 0 V, then Program Enable (\bar{S} (PE)) is brought to V_{IL} which takes the device out of the program mode. The data supplied by the programmer must be removed before the address is changed since the program inputs are now data outputs and change of address could cause a voltage conflict on the output buffer. Q1-Q8 outputs are invalid up to 10 microseconds after the program enable pin is brought from $V_{IH(PE)}$ to V_{IL} .

logic symbol†

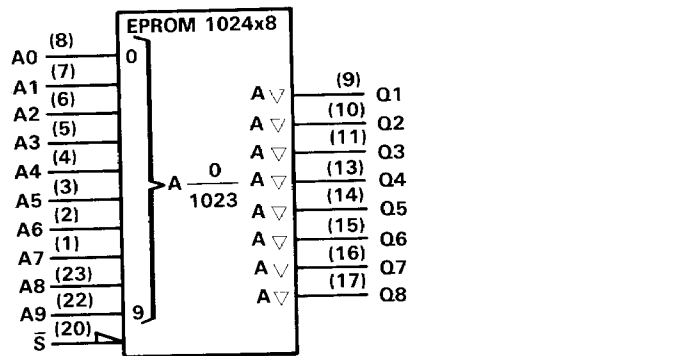

†This symbol is in accordance with IEEE Std 91/ANSI Y32.14 and recent decisions in IEEE and IEC. See explanation on page 10-1.

absolute maximum ratings over operating free-air temperature range (unless otherwise noted)‡

Supply voltage, V_{BB} (see Note 1)	-0.3 V to 7 V
Supply voltage, V_{CC} (see Note 1)	-0.3 V to 15 V
Supply voltage, V_{DD} (see Note 1)	-0.3 V to 20 V
Supply voltage, V_{SS} (see Note 1)	-0.3 V to 15 V
All input voltage (except program) (see Note 1)	-0.3 V to 20 V
Program input (see Note 1)	-0.3 V to 35 V
Output voltage (operating, with respect to V_{SS})	-2 V to 7 V
Operating free-air temperature range: TMS†	0°C to 70°C
Operating case temperature range: SMJ†	-65°C to 150°C
Storage temperature range	-55°C to 125°C

‡Stresses beyond those listed under "Absolute Maximum Ratings" may cause permanent damage to the device. This is a stress rating only and functional operation of the device at these or any other conditions beyond those indicated in the "Recommended Operating Conditions" section of this specification is not implied. Exposure to absolute-maximum-rated conditions for extended periods may affect device reliability.

NOTE 1: Under absolute maximum ratings, voltage values are with respect to the most-negative supply voltage. V_{BB} (substrate), unless otherwise noted. Throughout the remainder of this data sheet, voltage values are with respect to V_{SS} .

TMS2708, TMS27L08
1024-WORD BY 8-BIT ERASABLE PROGRAMMABLE READ-ONLY MEMORIES

recommended operating conditions

PARAMETER	TMS2708-35 TMS2708-45			TMS27L08-45			UNIT
	MIN	NOM	MAX	MIN	NOM	MAX	
Supply voltage, V_{BB}	-4.75	-5	-5.25	-4.5	-5	-5.5	V
Supply voltage, V_{CC}	4.75	5	5.25	4.5	5	5.5	V
Supply voltage, V_{DD}	11.4	12	12.6	10.8	12	13.2	V
Supply voltage V_{SS}	0			0			V
High-level input voltage, V_{IH} (except program and program enable)	2.4	$V_{CC} + 1$		2.2	$V_{CC} + 1$		
High-level program enable input voltage, $V_{IH}(PE)$	11.4	12	12.6	10.8	12	13.2	V
High-level program input voltage, $V_{IH}(PR)$	25	26	27	25	26	27	V
Low-level input voltage, V_{IL} (except program)	V_{SS}		0.65	V_{SS}		0.65	V
Low-level program input voltage, $V_{IL}(PR)$ Note: $V_{IL}(PR) \max \leq V_{IH}(PR) - 25$ V	V_{SS}		1	V_{SS}		1	V
High-level program pulse input current (sink), $I_{IH}(PR)$			40			40	mA
Low-level program pulse input current (source), $I_{IL}(PR)$			3			3	mA
Operating free-air temperature, T_A	0	70		0	70		°C

electrical characteristics over full ranges of recommended operating conditions (unless otherwise noted)

PARAMETER	TEST CONDITIONS	TMS2708-35 TMS2708-45			TMS27L08-45			UNIT
		MIN	TYP [†]	MAX	MIN	TYP [†]	MAX	
V_{OH} High-level output voltage	$I_{OH} = -100 \mu A$	3.7			3.7			V
	$I_{OH} = -1$ mA	2.4			2.4			
V_{OL} Low-level output voltage	$I_{OL} = 1.6$ mA	0.45			0.40			V
I_I Input current (leakage)	$V_I = 0$ V to 5.25 V	1 10			1 10			μA
I_O Output current (leakage)	$\bar{S} (PE) = 5$ V, $V_O = 0.4$ V to 5.25 V	1 10			1 10			μA
I_{BB} Supply current from V_{BB}	All inputs high, $\bar{S} (PE) = 5$ V, $T_A = ^\circ C$ (worst case)	30 45			9 18			mA
I_{CC} Supply current from V_{CC}		6 10			0.9 6			mA
I_{DD} Supply current from V_{DD}		50 65			20 34			mA
$P_{D(AV)}$ Power Dissipation	$T_A = 70^\circ C$	800			350			mW
	$T_A = 0^\circ C, \bar{S} = 0$ V				245 475			
	$T_A = 0^\circ C, \bar{S} = +5$ V				290 580			

capacitance over recommended supply voltage range and operating free-air temperature range, $f = 1$ MHz[†]

PARAMETER	TMS [*]		UNIT
	TYP [‡]	MAX	
C_i Input capacitance	4	6	pF
C_o Output capacitance	8	12	pF

[†]This parameter is tested on sample basis only.

[‡]All typical values are at $T_A = 25^\circ C$ and nominal voltages.

6

EPROM Devices

TMS2708, TMS27L08
1024-WORD BY 8-BIT ERASABLE PROGRAMMABLE READ-ONLY MEMORIES

switching characteristics over recommended supply voltage range and operating free-air temperature range

PARAMETER	TEST CONDITIONS	TMS2708-35		TMS2708 TMS27L08		UNIT	
		MIN	MAX	MIN	MAX		
$t_{a(A)}$ Access time from Address	$C_L = 100 \text{ pF}$ 1 Series 54/74 TTL load $t_f(S), t_f(A) = 20 \text{ ns}$		350		450	ns	
$t_{a(S)}$ Access time from \bar{S}			120		120	ns	
$t_{v(A)}$ Output data valid after address change			0		0	ns	
t_{dis} Output disable time [†]			0	120	0	120	ns
$t_{c(rd)}$ Read cycle time			350		450	ns	

[†]Value calculated from 0.5 volt delta to measured output level.

recommended timing requirements for programming $T_A = 25^\circ\text{C}$

PARAMETER	TMS [*]		UNIT
	MIN	MAX	
$t_w(PR)$ Pulse duration, program pulse	0.1	1	ms
t_t Transition times (except program pulse)		20	ns
$t_t(PR)$ Transition times, program pulse	50	2000	ns
$t_{su(A)}$ Address setup time	10		μs
$t_{su(D)}$ Data setup time	10		μs
$t_{su(PE)}$ Program enable setup time	10		μs
$t_h(A)$ Address hold time	1000		ns
$t_h(DA)$ Address hold time after program input data stopped	0		ns
$t_h(D)$ Data hold time	1000		ns
$t_h(PE)$ Program enable hold time	500		ns
t_{SLAX} Delay time, $\bar{S}(PE)$ low to address change	0		ns

6

EPROM Devices

SMJ2708, SMJ27L08 1024-WORD BY 8-BIT ERASABLE PROGRAMMABLE READ-ONLY MEMORIES

recommended operating conditions

PARAMETER	SMJ2708-35 SMJ2708-45			SMJ27L08-45			UNIT
	MIN	NOM	MAX	MIN	NOM	MAX	
Supply voltage, V_{BB}	-4.75	-5	-5.25	-4.5	-5	-5.5	V
Supply voltage, V_{CC}	4.75	5	5.25	4.5	5	5.5	V
Supply voltage, V_{DD}	11.4	12	12.6	10.8	12	13.2	V
Supply voltage V_{SS}	0			0			V
High-level input voltage, V_{IH} (except program and program enable)	2.4	$V_{CC} + 1$		2.2	$V_{CC} + 1$		
High-level program enable input voltage, $V_{IH}(PE)$	11.4	12	12.6	10.8	12	13.2	V
High-level program input voltage, $V_{IH}(PR)$	25	26	27	25	26	27	V
Low-level input voltage, V_{IL} (except program)	V_{SS}		0.65	V_{SS}		0.65	V
Low-level program input voltage, $V_{IL}(PR)$ Note: $V_{IL}(PR) \text{ max} \leq V_{IH}(PR) - 25 \text{ V}$	V_{SS}		1	V_{SS}		1	V
High-level program pulse input current (sink), $I_{IH}(PR)$	40			40			mA
Low-level program pulse input current (source), $I_{IL}(PR)$	3			3			mA
Operating case temperature, T_C	-55		125	-55		125	$^{\circ}\text{C}$

electrical characteristics over full ranges of recommended operating conditions (unless otherwise noted)

PARAMETER	TEST CONDITIONS	SMJ2708-35 SMJ2708-45			SMJ27L08-45			UNIT
		MIN	TYP [†]	MAX	MIN	TYP [†]	MAX	
V_{OH} High-level output voltage	$I_{OH} = -100 \mu\text{A}$	3.7			3.7			V
	$I_{OH} = -1 \text{ mA}$	2.4			2.4			
V_{OL} Low-level output voltage	$I_{OL} = 1.6 \text{ mA}$	0.45			0.40			V
I_I Input current (leakage)	$V_I = 0 \text{ V to } 5.25 \text{ V}$	1 10			1 10			μA
I_O Output current (leakage)	$\bar{S} (PE) = 5 \text{ V},$ $V_O = 0.4 \text{ V to } 5.5 \text{ V}$	1 10			1 10			μA
I_{BB} Supply current from V_{BB}	All inputs high, $\bar{S} (PE) = 5 \text{ V},$	30 45			9 18			mA
I_{CC} Supply current from V_{CC}		6 10			0.9 6			mA
I_{DD} Supply current from V_{DD}		50 65			20 34			mA

capacitance over recommended supply voltage range and operating case temperature range, $f = 1 \text{ MHz}^{\dagger}$

PARAMETER	SMJ [†]		UNIT
	TYP [†]	MAX	
C_i Input capacitance	4	6	pF
C_o Output capacitance	8	12	pF

[†]This parameter is tested on sample basis only.

^{††}All typical values are at $T_C = 25^{\circ}\text{C}$ and nominal voltages.

6

EPROM Devices

SMJ2708, SMJ27L08
1024-WORD BY 8-BIT ERASABLE PROGRAMMABLE READ-ONLY MEMORIES

switching characteristics over recommended supply voltage range and operating case temperature range

PARAMETER	TEST CONDITIONS	SMJ2708-35		SMJ2708 SMJ27L08		UNIT
		MIN	MAX	MIN	MAX	
t _a (A)	Access time from Address	350		450		ns
t _a (S)	Access time from \bar{S}	120		120		ns
t _v (A)	Output data valid after address change	0		0		ns
t _{dis}	Output disable time [†]	0 120		0 120		ns
t _c (rd)	Read cycle time	350		450		ns

[†]Value calculated from 0.5 volt delta to measured output level.

recommended timing requirements for programming T_C = 25°C

PARAMETER	DESCRIPTION	SMJ'		UNIT
		MIN	MAX	
t _w (PR)	Pulse duration, program pulse	0.1	1	ms
t _t	Transition times (except program pulse)	20		ns
t _t (PR)	Transition times, program pulse	50	2000	ns
t _{su} (A)	Address setup time	10		μs
t _{su} (D)	Data setup time	10		μs
t _{su} (PE)	Program enable setup time	10		μs
t _h (A)	Address hold time	1000		ns
t _h (DA)	Address hold time after program input data stopped	0		ns
t _h (D)	Data hold time	1000		ns
t _h (PE)	Program enable hold time	500		ns
t _{SLAX}	Delay time, \bar{S} (PE) low to address change	0		ns

6

EPROM Devices

TMS2708, TMS27L08
SMJ2708, SMJ27L08
1024-WORD BY 8-BIT ERASABLE PROGRAMMABLE READ-ONLY MEMORIES

PARAMETER MEASUREMENT INFORMATION

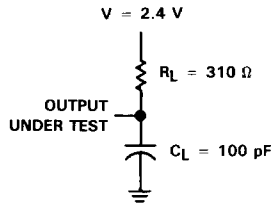
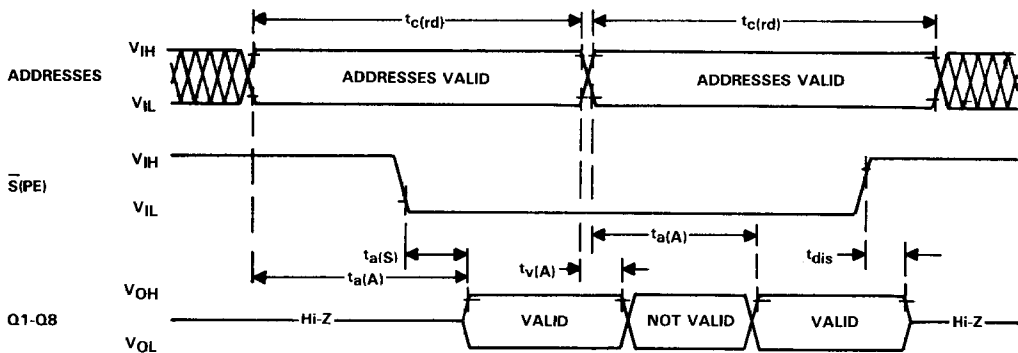
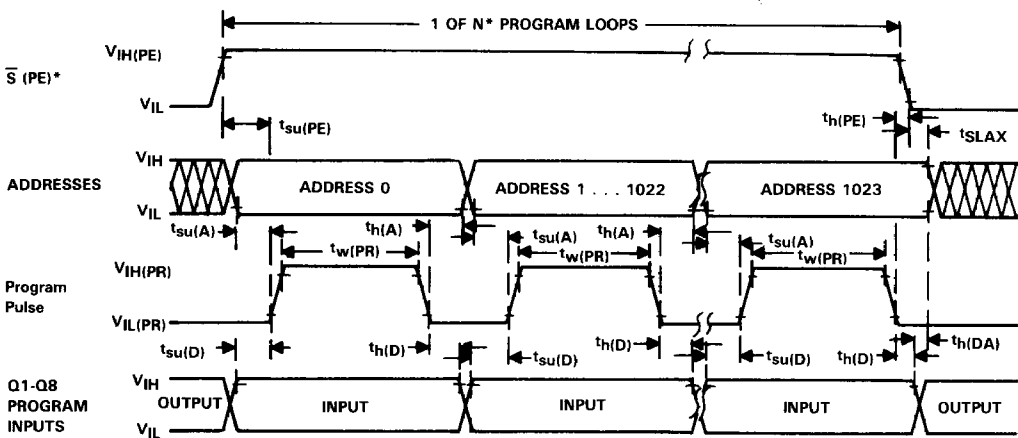

FIGURE 1 - TYPICAL OUTPUT LOAD CIRCUIT

read cycle timing



program cycle timing



* $\overline{S}(PE)$ is at +12 V through N program loops where $N < 100\text{ ms}/t_w(PR)$.
 NOTE: Q1-Q8 outputs are invalid up to 10 μsec after programming $\overline{S}(PE)$ goes low.
 All timing reference points in this data sheet (inputs and outputs) are 90% points.

6

EPROM Devices

TMS2708, TMS27L08
SMJ2708, SMJ27L08
1024-WORD BY 8-BIT ERASABLE PROGRAMMABLE READ-ONLY MEMORIES

TYPICAL '27L08-45 CHARACTERISTICS

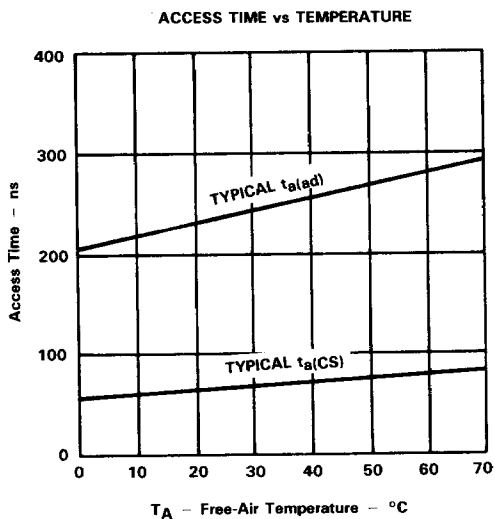
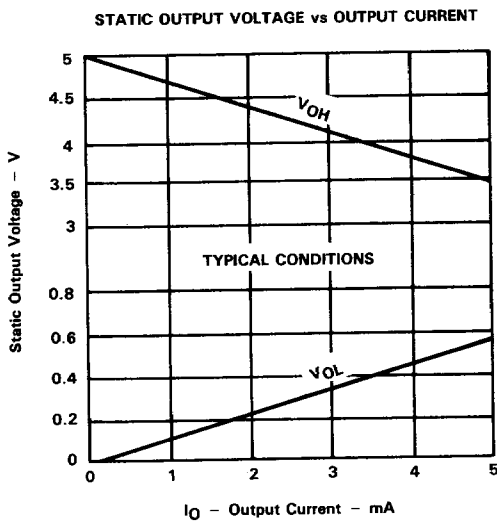
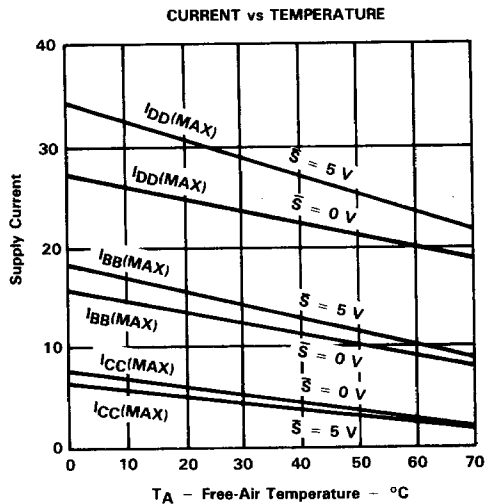
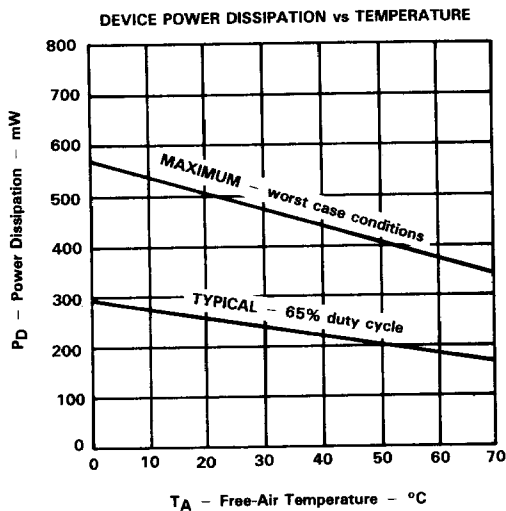

Texas Instruments reserves the right to make changes at any time in order to improve design and to supply the best product possible.

6

EPROM Devices